

Varilni nastavek za cev

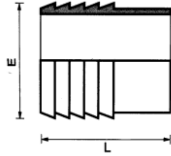

Kvaliteta: AISI 304

šifra code

DN	E	L	
25	34	42	P0208 A22
32	40	45	P0208 A27
40	48	52	P0208 A31
50	60	59	P0208 A39
65	76	72	P0208 A42
80	89	73	P0208 A46
100	114	95	P0208 A50

Hose nozzle

Matica

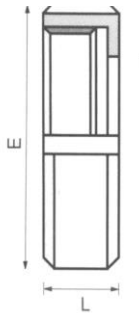

Kvaliteta: AISI 304, AISI 316L

Nut

DIN 11851 : 1998 DIN 2

šifra code

DN	E	I	L	
15	44	25	18	P0220 AAA09
20	54	31	21	P0220 AAA13
25	63,5	36	21	P0220 AAA18
32	70	42	21	P0220 AAA23
40	78	49	21	P0220 AAA27
50	92	62	22	P0220 AAA35
60	100	69	24	P0220 AAA38
65	112	80	25	P0220 AAA41
80	127	94	29	P0220 AAA45
100	148	115	30	P0220 AAA48

Priključek z navojem za valcanje

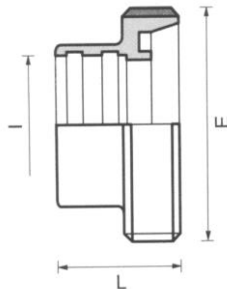

Kvaliteta: AISI 304, AISI 316L

Expanding male part

DIN 11851 : 1998 DIN 2

šifra code

DN	E	I	L	
15	34-8	18	21	P0220 AAD09
20	44-6	22	24	P0220 AAD13
25	52-6	28	28	P0220 AAD18
32	58-6	34	31	P0220 AAD23
40	65-6	40	32	P0220 AAD27
50	78-6	52	34	P0220 AAD35
60	84-6	60	38	P0220 AAD38
65	95-6	70	38	P0220 AAD41
80	110-4	85	43	P0220 AAD45
100	130-4	101,6	52	P0220 AAD48

Priključek z navojem za varjenje debelostenski

Welding male part thick

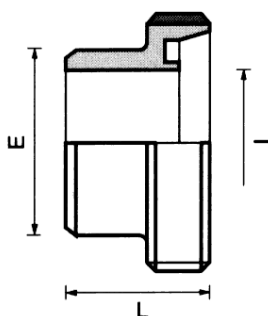

Kvaliteta: AISI 304, AISI 316L

šifra code

DN	E	I	L	šifra code
15	24	16	21	P0220 AAC09
20	30	20	24	P0220 AAC13
25	35	25	29	P0220 AAC18
32	41	31	32	P0220 AAC23
40	48	37	33	P0220 AAC27
50	61	49	35	P0220 AAC35
60	68	56	38	P0220 AAC38
65	79	66	40	P0220 AAC41
80	93	81	45	P0220 AAC45
100	114	97,6	54	P0220 AAC48

Priključek z navojem za varjenje

Welding male part super thin

DIN 11851 : 1998 DIN 2

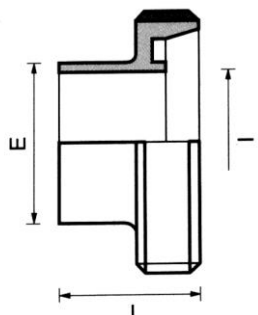

Kvaliteta: AISI 304, AISI 316L

šifra code

DN	E	I	L	šifra code
15	19	16	21	P0220 CAB10
20	23	20	24	P0220 CAB14
25	29	26	28	P0220 CAB19
32	35	32	31	P0220 CAB24
40	41	38	32	P0220 CAB27
50	53	50	34	P0220 CAB36
65	70	66	38	P0220 CAB41
80	85	81	43	P0220 CAB45
100	101,6	97,6	52	P0220 CAB47

Konusni priključek za valcanje

Expanding liner

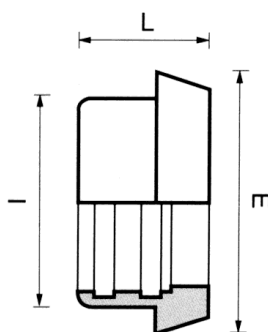

Kvaliteta: AISI 304, AISI 316L

šifra code

DN	E	I	L	šifra code
15	28	24	17	P0220 AAG09
20	36	30	18	P0220 AAG13
25	44	35	21	P0220 AAG18
32	50	41	24	P0220 AAG23
40	56	48	25	P0220 AAG27
50	68	61	27	P0220 AAG35
60	76	68	31	P0220 AAG38
65	86	76	32	P0220 AAG41
80	100	93	36	P0220 AAG45
100	121	114	43	P0220 AAG48

Konusni priključek za varjenje debelostenski

Welding liner thick

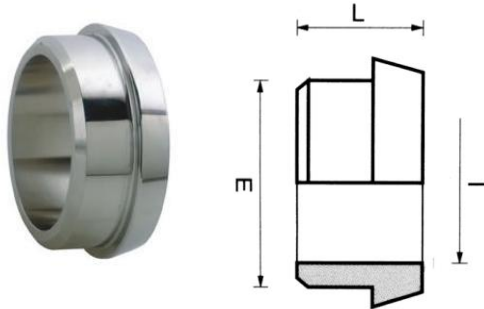

Kvaliteta: AISI 304, AISI 316L

šifra code

DN	E	I	L	
15	24	16	17	P0220 AAF09
20	30	20	18	P0220 AAF13
25	35	25	22	P0220 AAF18
32	41	31	25	P0220 AAF23
40	48	37	26	P0220 AAF27
50	61	49	28	P0220 AAF35
60	68	56	31	P0220 AAF38
65	79	66	32	P0220 AAF41
80	93	81	37	P0220 AAF45
100	114	97,6	44	P0220 AAF48

Konusni priključek za varjenje

Welding liner part super thin
DIN 11851 : 1998 DIN 2

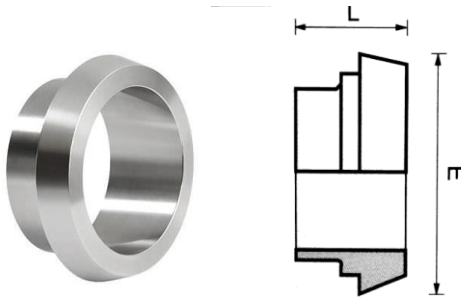

Kvaliteta: AISI 304, AISI 316L

šifra code

DN	E	I	L	
15	19	16	17	P0220 CAE10
20	23	20	18	P0220 CAE14
25	29	26	21	P0220 CAE19
32	35	32	24	P0220 CAE24
40	41	38	25	P0220 CAE27
50	53	50	27	P0220 CAE36
65	70	66	32	P0220 CAE41
80	85	81	36	P0220 CAE45
100	101,6	97	43	P0220 CAE47

Nastavek za cev s konusom

Liner hose fitting

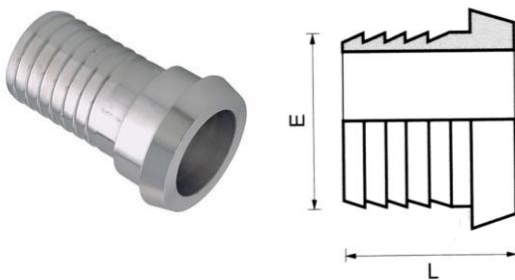

Kvaliteta: AISI 304

šifra code

DN	E	F	L	
15	24	28	36	P0220 AAL09
20	30	36	38	P0220 AAL13
25	34	44	40	P0220 AAL18
32	40	50	40	P0220 AAL23
40	46	56	45	P0220 AAL27
50	58	68	51	P0220 AAL35
65	76	86	62	P0220 AAL41
80	93	100	62	P0220 AAL45
100	114	121	80	P0220 AAL47

Nastavek za cev z navojem

Male part hose fitting

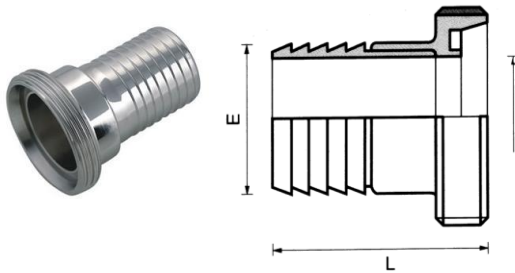

Kvaliteta: AISI 304

šifra code

DN	E	L	I	šifra code
25	34	55	25	P0220 AAN18
32	40	58	32	P0220 AAN23
40	46	64	37	P0220 AAN27
50	58	71	49	P0220 AAN35
65	76	87	66	P0220 AAN41
80	93	88	81	P0220 AAN45
100	114	112	100	P0220 AAN48

Slepa matica z verigo

Blind nut with chain

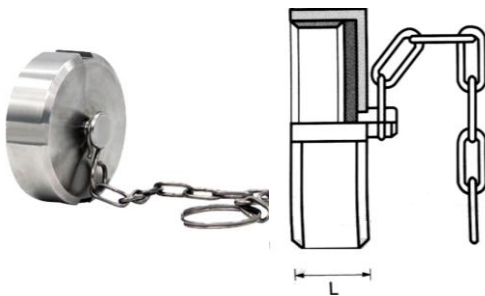

Kvaliteta: AISI 304

šifra code

DN	E	L	šifra code
15	44	18	P0220 AAH09
20	54	20	P0220 AAH13
25	63	21	P0220 AAH18
32	70	21	P0220 AAH23
40	78	21	P0220 AAH27
50	92	22	P0220 AAH32
65	112	25	P0220 AAH41
80	127	29	P0220 AAH45
100	148	31	P0220 AAH48

Tesnilo za DIN spojke

Gasket DIN 11851 : 1998 DIN 2

Kvaliteta: NBR, EPDM, SILIKON, TEFLON

šifra code

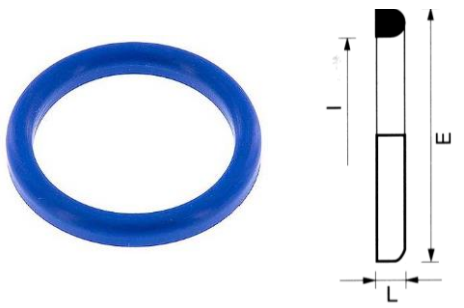

DN	E	L	šifra code
15	26	4	P0220 AIK09
20	33	4	P0220 AIK13
25	40	5	P0220 AIK18
32	46	5	P0220 AIK21
40	52	5	P0220 AIK27
50	64	5	P0220 AIK35
60	72	5	P0220 AIK38
65	81	5	P0220 AIK41
80	95	5	P0220 AIK45
100	114	6	P0220 AIK48

Čep

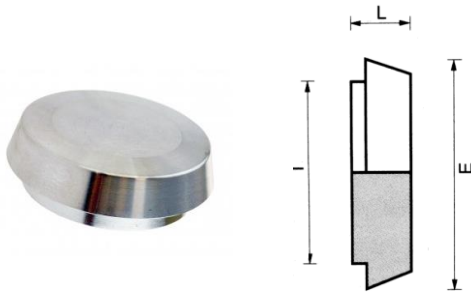

Liner blank

Kvaliteta: AISI 304

šifra code

DN	E	I	L	
15	28	24	12	P0220 AAM09
20	36	30	12	P0220 AAM13
25	44	35	14	P0220 AAM18
32	50	41	14	P0220 AAM23
40	56	48	14	P0220 AAM27
50	68	61	15	P0220 AAM35
65	86	79	17	P0220 AAM41
80	100	93	17	P0220 AAM45
100	121	114	21	P0220 AAM48

Objemka za cev

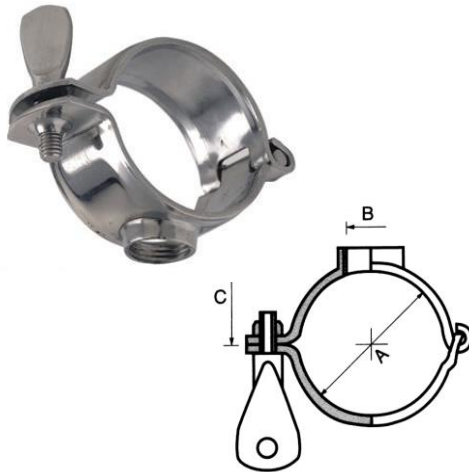

Pipe support

Kvaliteta: AISI 304

šifra code

A	B	C	
21,3	1/2"	18,7	P0222 AA12
25,4	1/2"	18,7	P0222 AA16
28	1/2"	25	P0222 AA18
33,7	1/2"	25	P0222 AA22
34	1/2"	25	P0222 AA23
38	1/2"	27	P0222 AA26
40	1/2"	28	P0222 AA27
42,4	1/2"	29	P0222 AA28
48,3	1/2"	32	P0222 AA31
50/52	1/2"	34	P0222 AA35
60,3	1/2"	38	P0222 AA39
63,5	1/2"	40	P0222 AA40
70	1/2"	43	P0222 AA41
76,1	1/2"	46	P0222 AA42

Nepovratni ventil

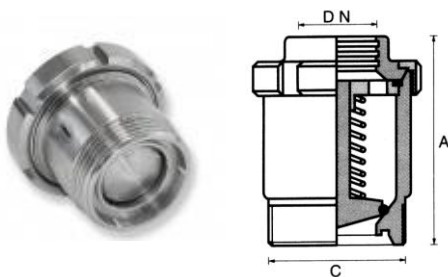

No return valve male / expanding

Kvaliteta: AISI 304, AISI 316L

šifra code

DN	A	B	C
25	94,5	78	52-6
32	99,5	92	58-6
40	105,5	92	65-6
50	112	112	78-6
65	131	138	95-6
80	148	148	110-4
100	158	148	130-4

Varilni nepovratni ventil

No return valve welding ends

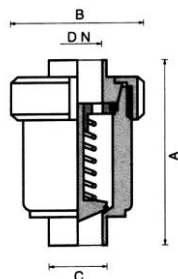

Kvaliteta: AISI 304, AISI 316L

šifra code

DN	A	B	C	šifra code
25	94,5	78	28	P0228 AAA18
32	99,5	92	34	P0228 AAA23
40	105,5	92	40	P0228 AAA27
50	112	112	52	P0228 AAA35
65	131	138	70	P0228 AAA41
80	148	148	85	P0228 AAA45
100	158	148	101,6	P0228 AAA48